

ES Características

Acabado fosfatado negro.
Acero especial al carbono para muelles.

Aplicaciones

Accesorio para soporte de cintas perforadas en vigas de madera.



PT Características

Acabamento fosfatado preto.
Aço especial de carbono para molas.

Aplicações

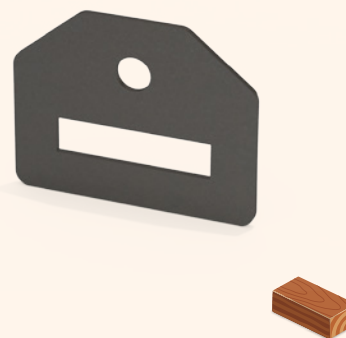
Acessório para suporte de cintas perfuradas em vigas de madeira.



ART	COD	A	B	Ød	 Kg max	
SOPORTE VERTICAL CINTA	C6500300	28	6,4	6,2	40	100
DATOS TÉCNICOS DADOS TÉCNICOS Medidas en mm Medidas em mm						

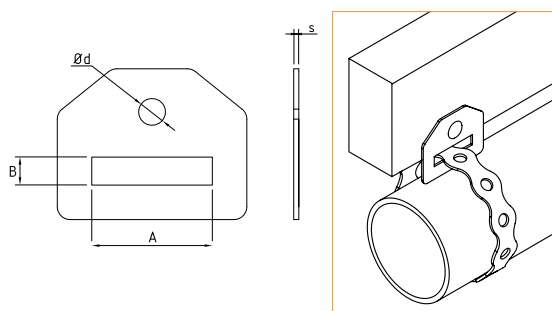

SOPORTE VERTICAL VARILLA M6 | SUPORTE VERTICAL VARÃO M6

ES Características

Acabado fosfatado negro.
Acero especial al carbono para muelles.

Aplicaciones

Accesorio para fijación colgante de varillas roscadas de M6.



PT Características

Acabamento fosfatado preto.
Aço especial de carbono para molas.









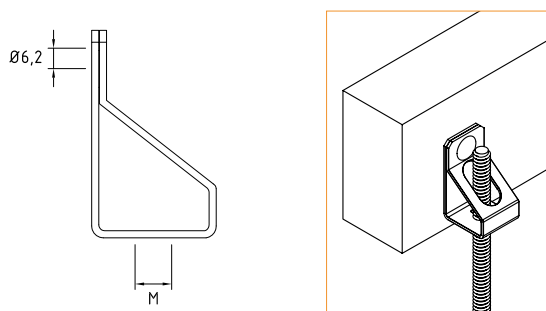

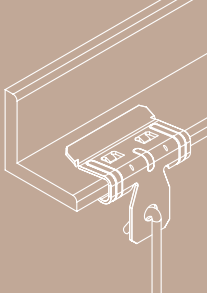

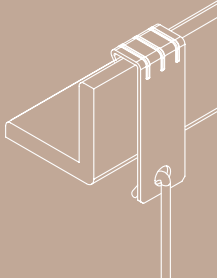

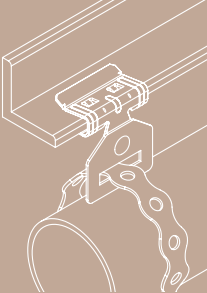
Aplicações

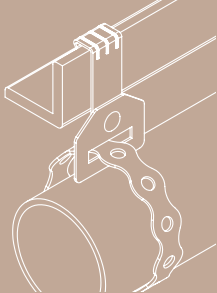
Acessório para fixação suspensa de pivots roscados M6.

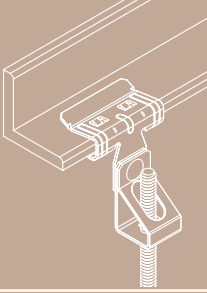

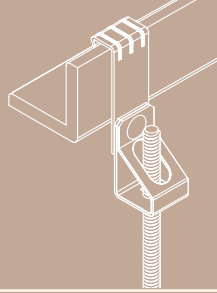
ART (M)	COD	 Kg max	
M6	C6500000	40	100
DATOS TÉCNICOS DADOS TÉCNICOS Medidas en mm Medidas em mm			

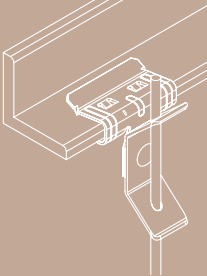

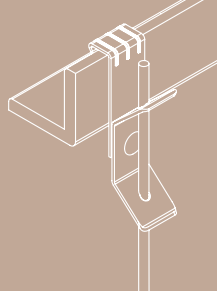
APLICACIÓN APLICAÇÃO	FIJACIÓN VIGA HORIZONTAL FIXAÇÃO VIGA HORIZONTAL		FIJACIÓN VIGA VERTICAL FIXAÇÃO VIGA VERTICAL	
GANCHOS GANCHOS				
CINTAS FITAS				
VARILLA ROSCADA VARÃO ROSCADA				
VARILLA LISA VARÃO LISA				

FIJACIÓN VIGA MADERA FIXAÇÃO VIGA MADEIRA			
			